

Elecnova



SFERE,ELECTRIC
APPLICATION SOLUTION EXPERT

JIANGSU SFERE ELECTRIC CO., LTD.

Add: No.1 Dongding Road, Jiangyin, Jiangsu, China

Tel: + 86-510-86199063

+ 86-510-86199069

+ 86-510-86199073

E-mail: export@sfere-elec.com

www.sfere-elec.net



Elecnova



► SFR-SVG

SFERE ELECTRIC

ELECTRIC APPLICATION SOLUTION EXPERT

2021



www.sfere-elec.net



NO.1 Dongding Road,
Jiangyin, Jiangsu,
China



export@sfere-elec.com

BACKGROUND REACTIVE POWER COMPENSATION

Power factor is a crucial technical data in the power system. It plays an important role to evaluate the utilization of the electrical equipment in the power system.

In the AC loop, the cosine value of the phase difference between the voltage vector to the current vector is the power factor (PF), represented by the sign of $\cos\phi$. Numerically, the power factor is the ratio of active power to the apparent power, that is $\cos\phi=P/S$.

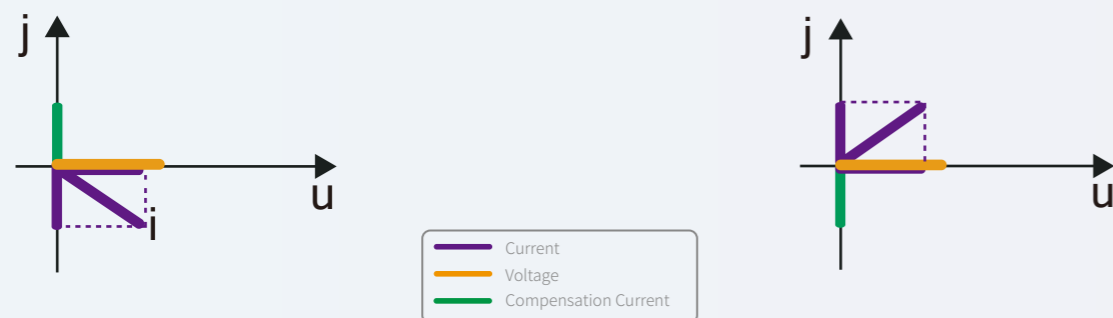
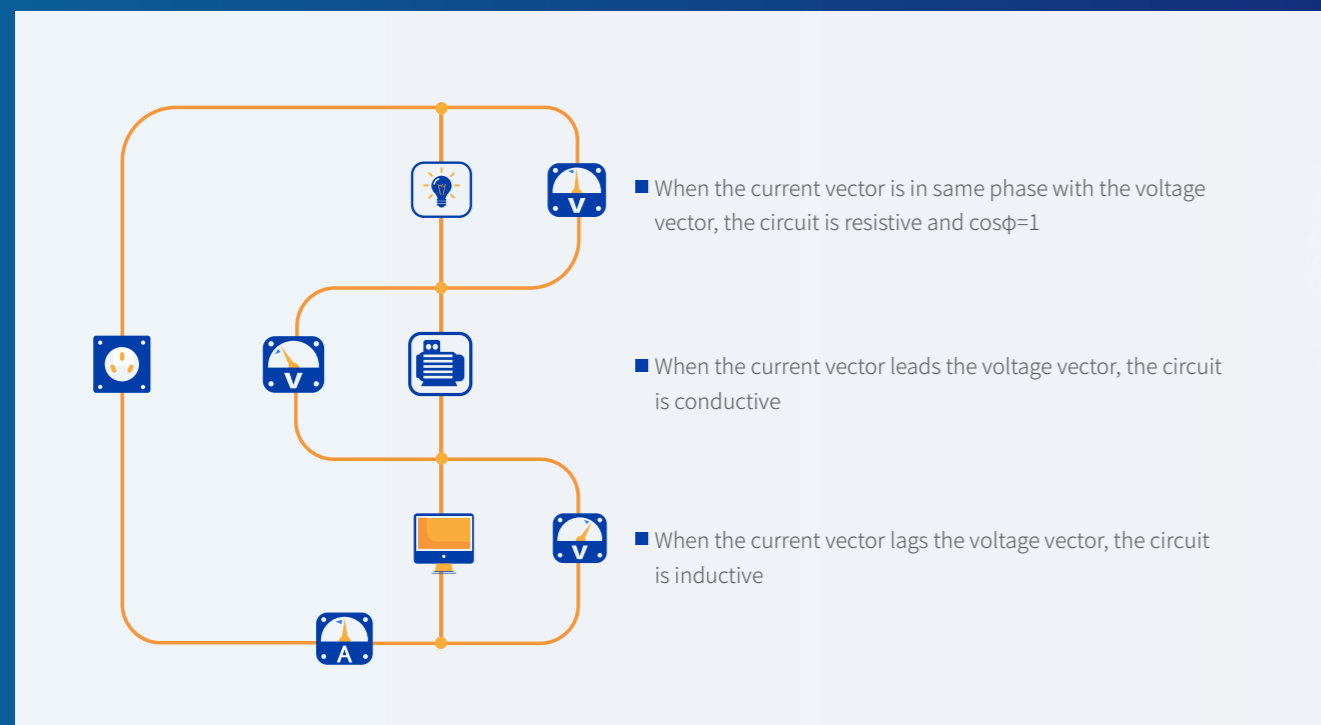

Because most of the electrical equipment is inductive load, the power factor is obviously less than 1 during operation, a large amount of reactive power needs to be taken from the grid. Therefore, in order to improve the power factor of the grid, it must compensate the reactive power in the grid.

BRIEF INTRODUCTION

SFR-SVG is a new-generation product of Static Var Generator(SVG), it used the latest technology application for the reactive power compensation. When the SFR-SVG parallel in the grid, it equalized as a dynamic reactive current source.The reactive current of the SVG could be flexibly controlled and compensate the reactive power automatically .

THE SIGNIFICANCE OF REACTIVE POWER COMPENSATION IS AS FOLLOWS



STABLE VOLTAGE

01

Stabilize the terminal voltage of the power grid and improve the quality of power supply.



INCREASE POWER FACTOR

02

Improve the power factor of the power system and the load, reduce the capacity of the power system and the substation equipment investment.



REDUCE LINE LOSS

03

Reduce line loss and improve the power transmission capacity of the power grid.



BALANCED POWER

04

Balancing the three-phase active power and reactive power of the grid.

SVG

The SVG acquires the current signal of the load by the CT, the DSP tracks the command current in quick than calculate the reactive power rate of change by intelligent algorithm as to send the data to the IGBT by PWM signal. Finally the inductive or conductive power compensation current is generated on the inverter to achieve the real-time dynamic reactive power compensation.

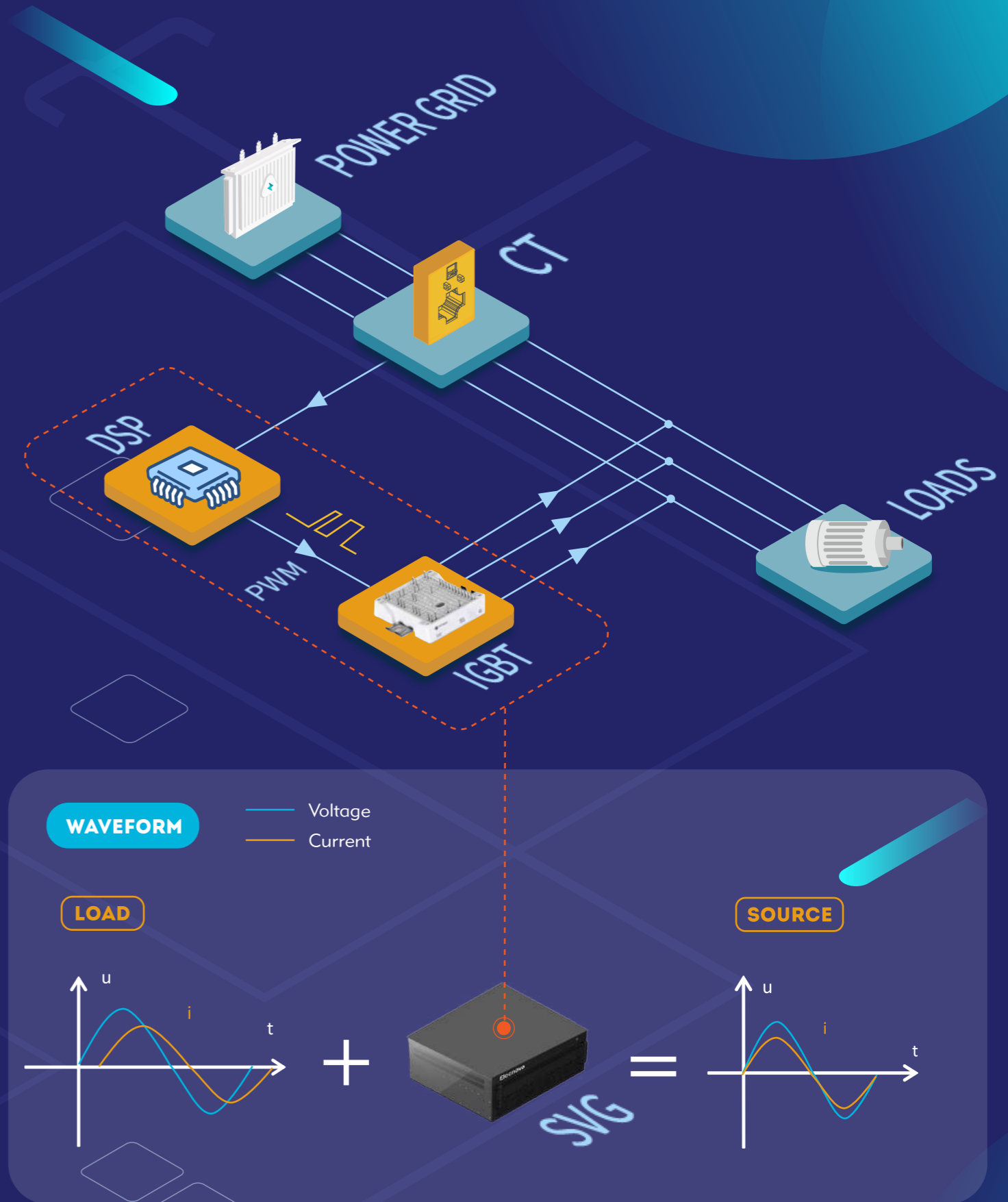



MAIN FEATURES

SFR-SVG is the type of IGBT compensation device, comparing to the conventional fixed capacitor compensation, mechanical switching capacitors and the thyristor switching capacitors, it has the following advantages:

SUPPORT ANTI-HARMONIC FUNCTION TO ENSURE SYSTEM SAFETY



SFR-SVG is a controllable current source, avoid harmonic amplification that may be caused by the capacitor bank which is connected in series with reactor, and prevent damage to other system equipment and compensation equipment due to harmonic over voltage.



DYNAMIC CONTINUOUS SMOOTH COMPENSATION

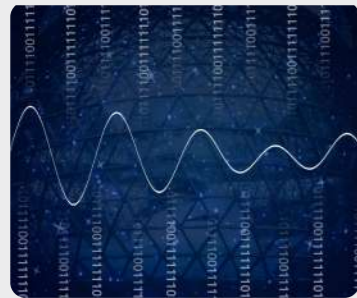

SFR-SVG can dynamically and continuously compensate the power factor accordance with the change of the load. The module could export reactive power but absorb reactive power as well, so as to completely eliminate the situation of reactive power reverse transmission.

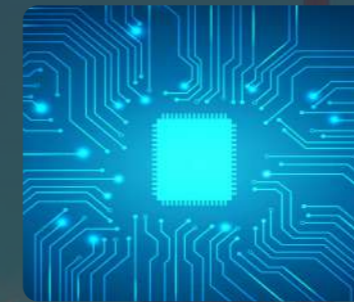

CURRENT SOURCE CHARACTERISTICS



The exportation of reactive current from the SFR-SVG is irrelevant to the voltage of the system. This is a great advantage when used for voltage control comparing to the conventional SVC which has impedance characteristics and the export current linearly decreases as the BUS voltage decreases.

FAST RESPONSE



The response time of SFR-SVG $\leq 5\text{ms}$, and the conversion from conductive reactive power to inductive reactive power can be accomplished in a very short time. The fast compensation speed can be fully qualified for impact load compensation.



EASY INSTALLATION AND LESS OCCUPATION SPACE



Compared with conventional reactive compensation products, the SFR-SVG can save 70% installation space.

MODEL DESCRIPTION

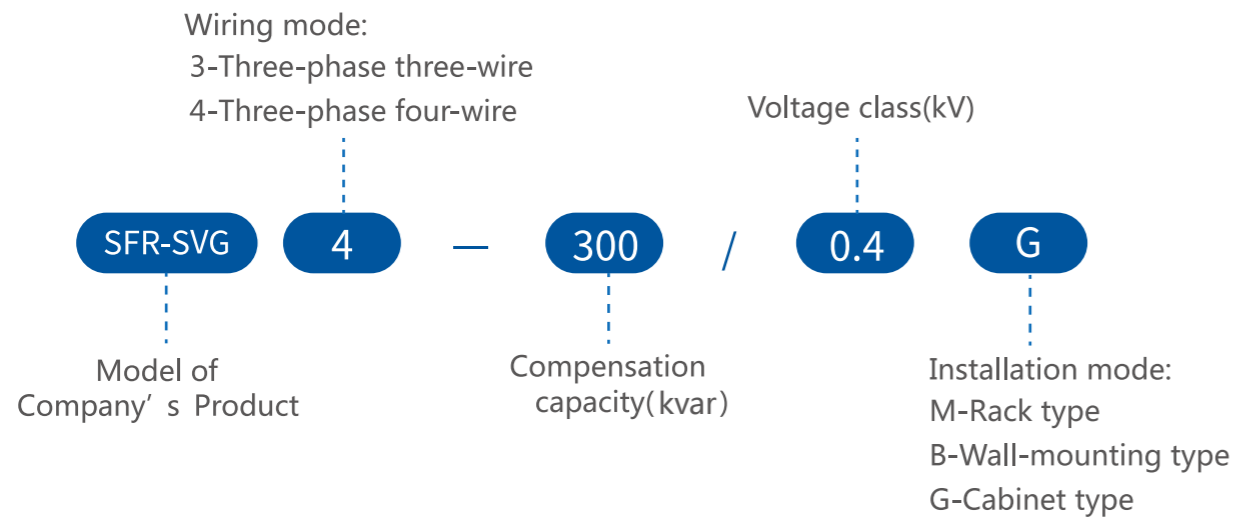

SFR-SVG									
Grid	400V				690V				
Mounting type	Rack-mounted		Wall-mounted		Cabinet	Floor model	Cabinet		
Rated capacity(kvar)	30	50	75	100	up to 400	150	175	200	Up to 800
Dimensions (W×H×D)mm ³	509×189×588	570×240×719	529×613×189	590×744×240	800×2200×800	300×1410×600	Up to 1500×2200×1000		
Net weight	33kg	58kg	33kg	58kg	300kg-400kg	150kg	300kg-700kg		

TABLE OF RAPID MODEL CHECKING OF SFSVG

Transformer Capacity (kVA)	Three phase four wire	Three phase three wire
200	SFR-SVG4-100/0.4 × 1	SFR-SVG3-100/0.4 × 1
250/315	SFR-SVG4-100/0.4 × 1	SFR-SVG3-100/0.4 × 1
400	SFR-SVG4-150/0.4 × 1	SFR-SVG3-200/0.4 × 1
500/630	SFR-SVG4-200/0.4 × 1	SFR-SVG3-300/0.4 × 1
800	SFR-SVG4-250/0.4 × 1	SFR-SVG3-400/0.4 × 1
1000	SFR-SVG4-300/0.4 × 1	SFR-SVG3-500/0.4 × 1
1250	SFR-SVG4-400/0.4 × 1	SFR-SVG3-300/0.4 × 2
1600	SFR-SVG4-250/0.4 × 2	SFR-SVG3-400/0.4 × 2
2000	SFR-SVG4-300/0.4 × 2	SFR-SVG3-500/0.4 × 2
2500	SFR-SVG4-400/0.4	SFR-SVG3-400/0.4 × 3
Scope of Application:	Business center, office building, hotel, hospital, data center, theater and other occasions with relatively much single-phase load	Chemical, metallurgy, communication, textile, papermaking, printing, tobacco, automobile, port and other occasions with relatively much three-phase load

Note: Types M, B and G can be selected according to field situation.

TECHNICAL PARAMETER

SFR-SVG				
Grid	400V		690V	
Mounting Type	Wall-mounted Rack-mounted	Cabinet	Floor model	Cabinet
System				
Rated Input	400V LL ±15%		690V LL ±15%	
Power Grid Frequency	50/60Hz ±5%			
Parallel Operation	8 modules, customizable			
Overall Efficiency	≥97%(laboratory data)			
Power Grid Structure	3P3W,3P4W		3P3W	
Circuit Topology	3-level			
Performance Indicators				
Rated Capacity	30kvar/50kvar/75kvar/100kvar	Up to 400kvar	150kvar/175kvar/200kvar	Up to 800kvar
Loss Of Active Power	<3% rated module power			
Over-load Capability	120%			
Response Time	5ms			
Scope Of Reactive Adjustment	Continuously adjustable from rated induced to rated capacitive			
Control Algorithm	Compensation algorithm of screening vector of frequency domain possessing self-adaptation capability			
Switching Frequency	20kHz			
Cooling Mode	Forced air cooling			
Noise Level	≤65dB			
Communications and Monitoring Capabilities				
Communications Port	RS485			
Communications Protocol	Modbus-RTU			
Module Display Interface	4.3in LCD/ LED indicator	7in/10in LCD touch screen(optional)	LED indicator	7in/10in LCD touch screen(optional)
Monitoring Alarm	Available			
Monitoring	Independent monitoring and centralized monitoring			
Environment Requirements				
Altitude	1,000m, for every increased 100m, the power is reduced by 1%.			
Operating Temperature	-20 C ~ 45 C			
Relative Humidity	5% to 95%,non-condensing			
Protection Class	IP20			
Related Standards				
Directive	2014/30/EU 2014/35/EU			
Standards Compliance	EN 61000-6-2:2005+AC:2005 EN 61000-6-4:2007+A1:2011 EN 50178:1997			

SVG



ELECTRIC APPLICATION SOLUTION EXPERT

STATIC VAR GENERATOR

WORLDWIDE PROJECTS

Xinjiang, Hami Hydropower Station

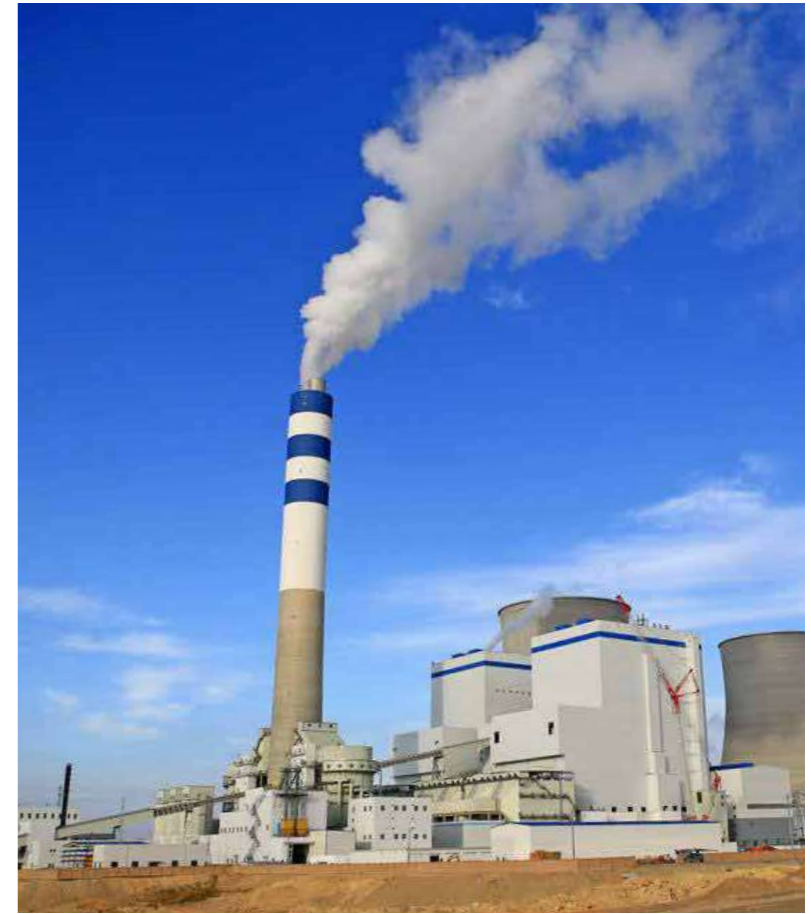





Zhuhai, Yanheng Land Commercial Complex



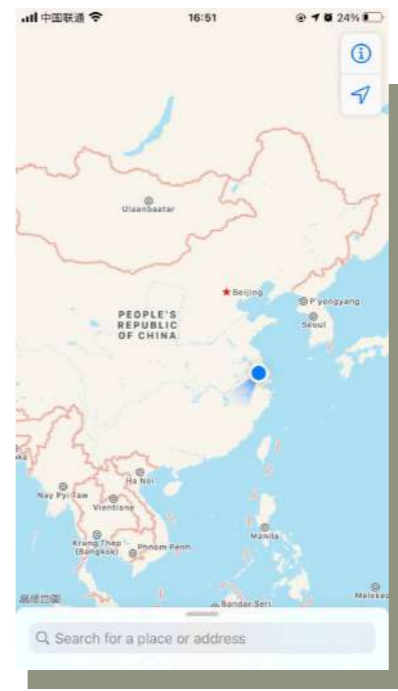

Beijing Kehua Zhongsheng Network Cloud Computing Engineering Company Project

JCET, jiangsu, china

